

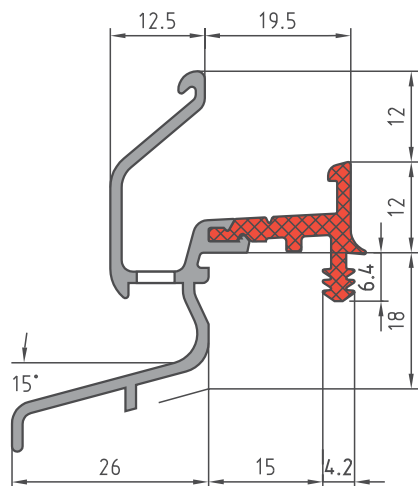

Bezeichnung Description	Typ Type	Seite Page
GTBSL 19	261 001	2-05
GTR 19.45	260 014	2-05
GTR 19.45 K	260 009	2-04
RD 19 K Stil	211 017	2-07
RD 19.45 K	211 023	2-07
TR 12.19 Stil	260 010	2-05
Halter Stilschiene	214 506	2-25
Befestigungsteil	210 863	2-25

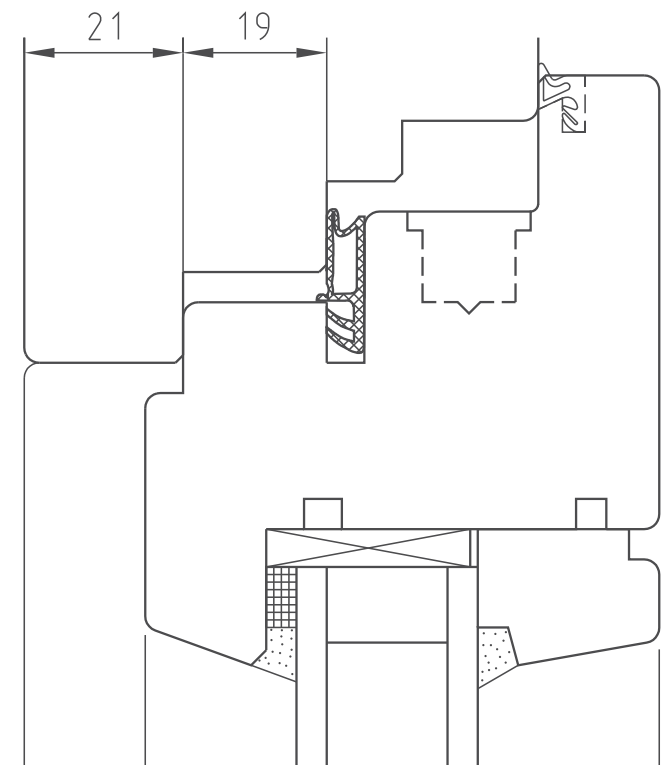

260 009 GTR 19.45 K



FA 21
214 330

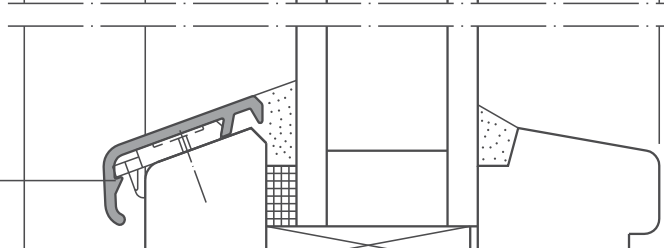

Passende Wetterschutzschienen für Fenstertüren
siehe Seite 2-05

Used weather bar for doors look at page 2-05

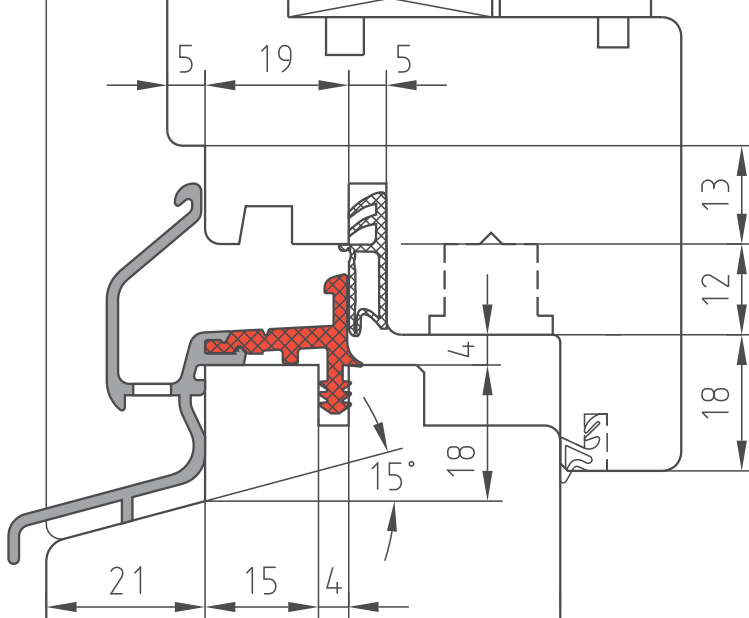

Einbaubeispiel GTR 19.45 K Installation example



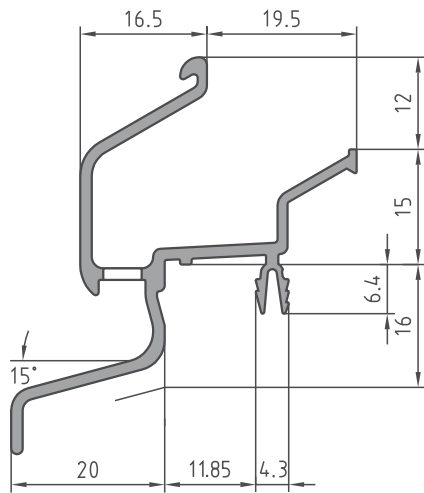

211 023 RD 19.45 K

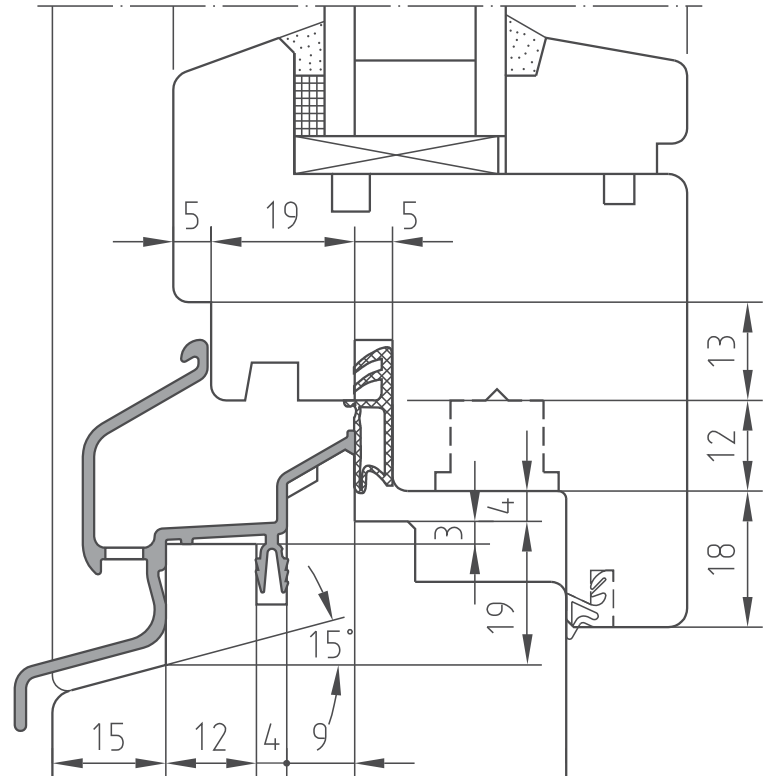

Einbaubeispiel RD 19.45 K Installation example

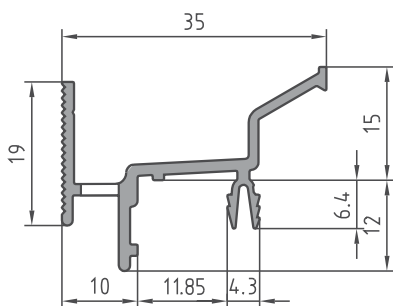

211 017 RD 19 K Stil

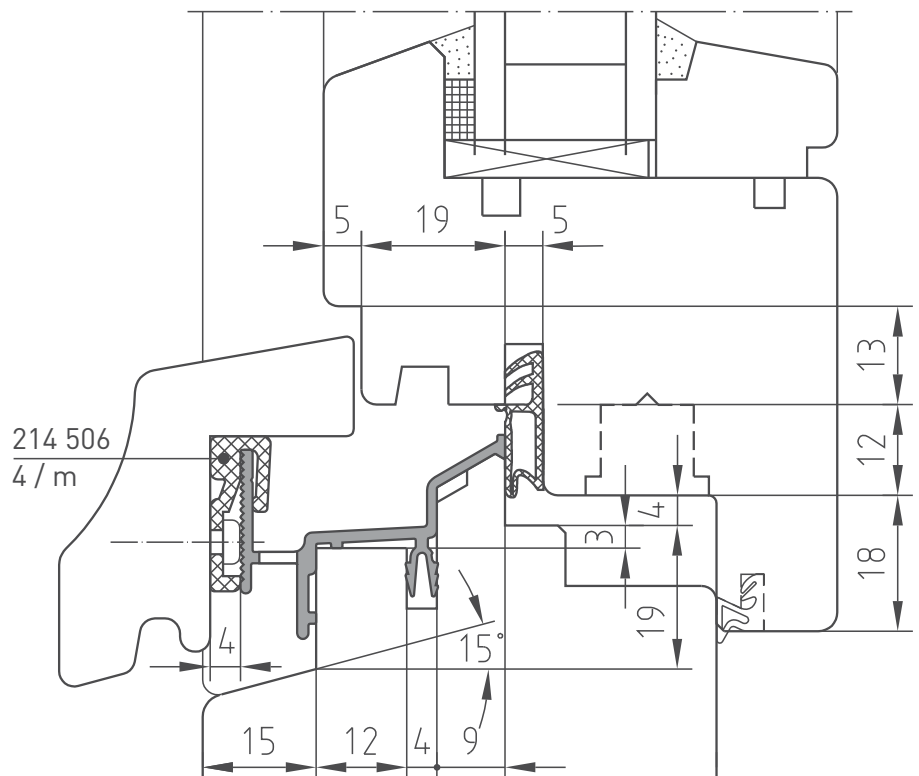

Einbaubeispiel RD 19 K Stil Installation example

Profil Profile	Typ Type	lagerhaltige Oberflächen available surfaces on stock					VE PU	Endkappen Endcaps	
		AU	BC 0	BC 2,5	BC 4	RAL 9016		links / left	rechts / right
RD 19.45 K	211 023	X					48 m	211 026	211 027
RD 19 K Stil	211 017	X					108 m	211 018	211 019

